

AUTOMATIC SWING DOOR OPERATOR



PROSWING, automation, for continuous and intensive service, power combined with compact design. Suitable to operate heavy and large doors, easy installation and operating.

- Heavy Duty
- "Low Energy" mode.
- Reduced speed and acceleration for environments used by people with limited and slow reaction capabilities, according to specific regulations and directives
- PUSH & GO mode
- Optional opening with remote control
- Compatible with different opening, safety and security devices
- Head fitted Switch, ON/OFF
- Head fitted Logic switch, Standard 3 Position

- Easy and intuitive parameters adjustment with double display on control board
- Works with different models of electric lock/magnet
- Cover in anodised aluminium, available on request RAL finishing
- Synchronised double door operators
- Option connection to BMS (Building Management System)
- High torque value
- Force adjustments for opening and closing in different environmental condition, wind or pressurised rooms
- Configuration on control board for 2 input 2 output auxiliary signals

Development, testing and production of PROSWING, as for all SESAMO products, according international standards ISO 9001.



ZD ZENITH DOORS

PROSWING AUTOMATIC SWING DOOR OPERATOR



PRODUCT RANGE

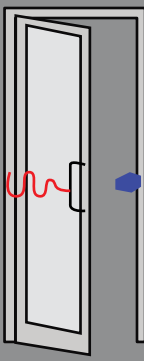

PROSWING S
Opened by motor, closing by spring
 Universal, mostly when the door has to close in case of power failure. In this case, the automation works as a spring.

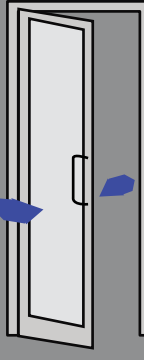

PROSWING M
Opened and closing by motor.
 For any kind of entrance, powerful and flexible, power battery kits as an option.

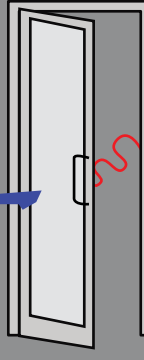

PROSWING R
Opening by spring, closing by motor.
 Inverse, it opens without power supply by spring, for ventilation and smoke clearance. This model can be used also in emergency exits.

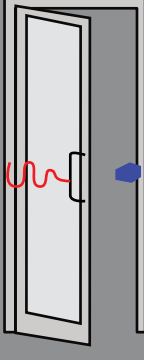

PROSWING F
Automation with integrated system that closes in case of fire/smoke alarm.
 Anywhere an automatic barrier for fire and smoke is required, for country specific directives and regulations must be followed.

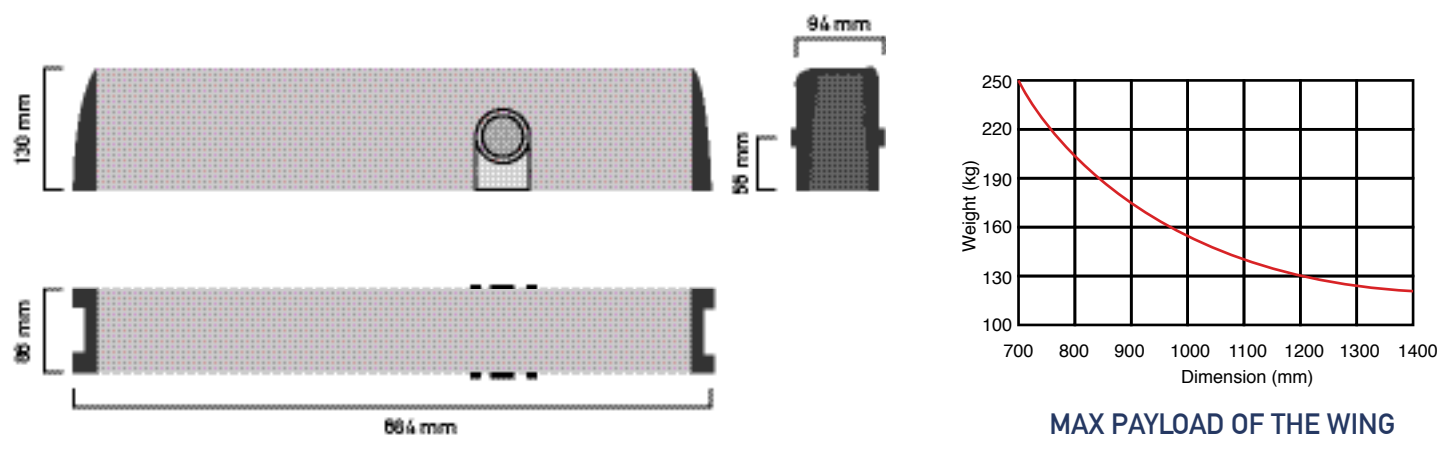

TECHNICAL SPECIFICATIONS

POWER SUPPLY	230 VAC - 50HZ	MAX PAYLOAD	250 Kg (see chart above)
NOMINAL POWER	85W	WING DIMENSIONS	700mm to 1400mm
POWER EXTERNAL DEVICES	12VDC - 12W Max.	OPERATING TEMPERATURE	-10°C a +50°C
EMERGENCY BATTERIES	2x12V 1.3Ah (Optional only for PROSWING M)	WEIGHT	12kg
PARAMETERS ADJUSTMENT	With double display with push buttons on control board, Dip-Switches or PC interface	DIMENSIONS	664 x 130 x 86mm
OPENING MAX. ANGLE	110°	SERVICE	Continuous
		ELECTRIC LOCK POWERS	12/24 Vdc - 15W max
		SPRING TENSION	EN4-EN6
		ARM SYSTEM	• Articulated Push Arm • Rigid Pull Arm

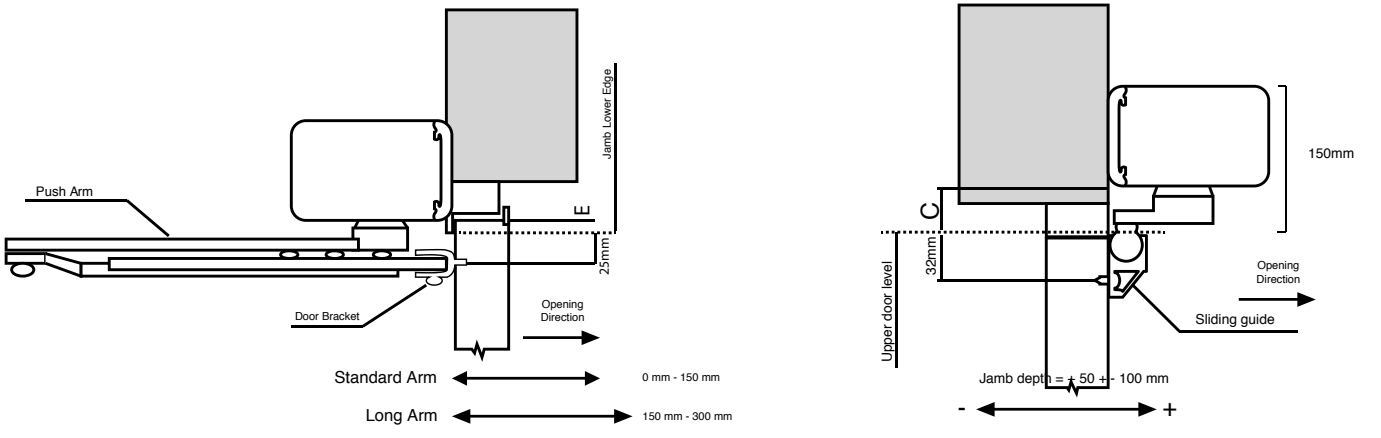
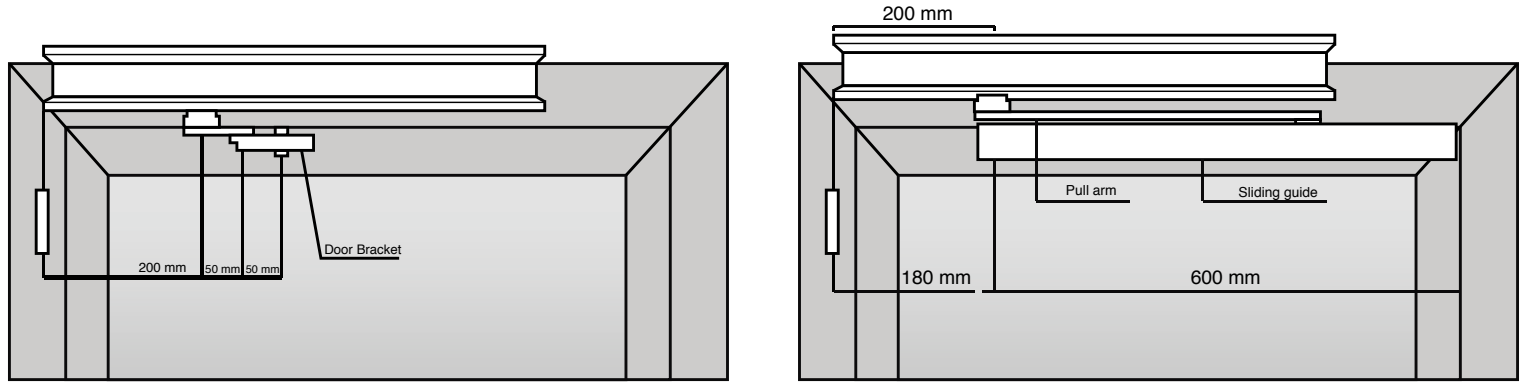

Arm extensions	Value E
L = 30 mm (standard)	8
L = 50 mm	28
L = 70 mm	48
L = 90 mm	68

Arm extensions	Value C
L = 30 mm (standard)	35
L = 50 mm	52
L = 70 mm	75
L = 90 mm	95

ACCESSORIES

MOVEMENT ARMS



COMPLEMENTARY ACCESSORIES



TRIGGER DEVICES AND SAFETY

